

TOP VIEW

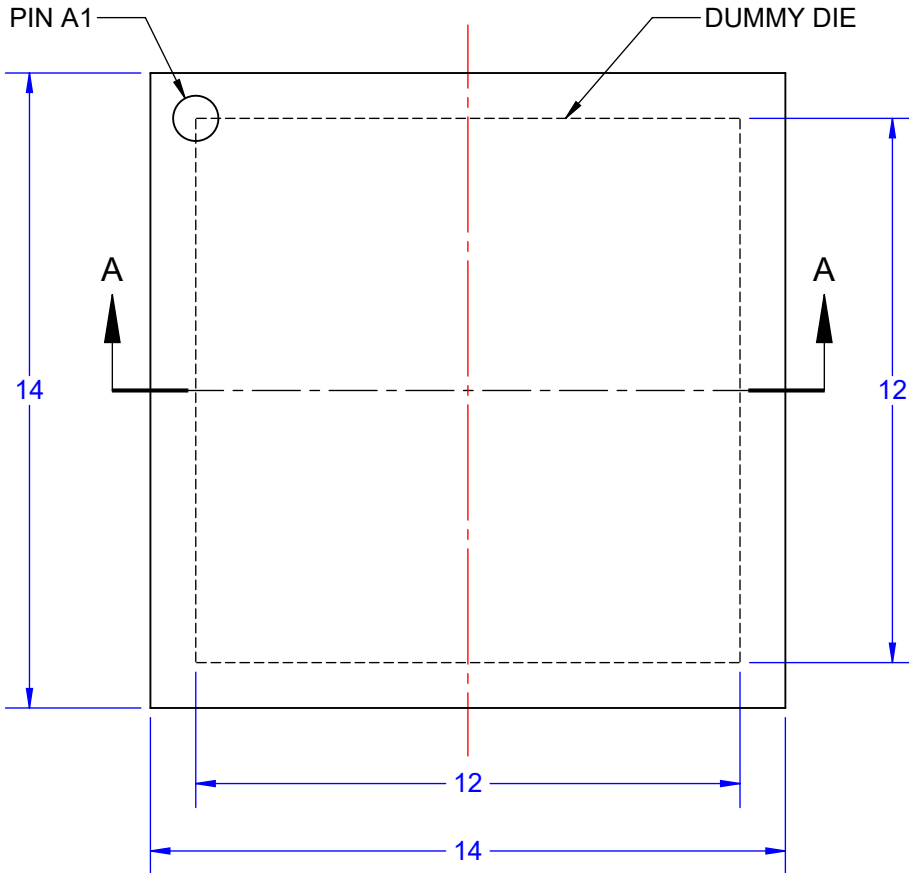

PAD VIEW

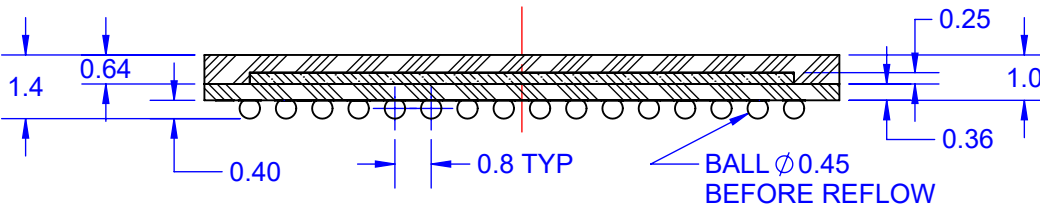
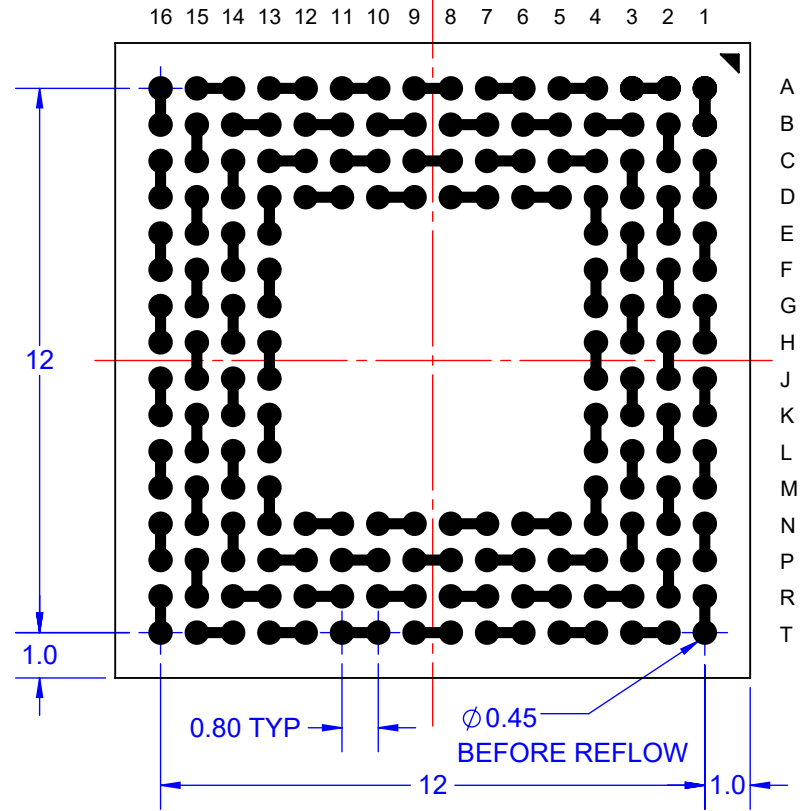

SECTION A-A
SCALE 6 : 1

Notes: (Unless Otherwise Specified).

1. DIMENSIONS: MM.
2. SOLDER BALL ALLOY: SEE PART NUMBER TABLE.
3. BALL DIAMETER (BEFORE REFLOW): 0.45mm (18 mil).
4. SOLDER MASK DEFINED PAD OPENING: 0.40mm (15.7 mil).
5. PAD MATERIAL: PAD Cu DIAMETER 0.50mm (19.7mil).
6. SUBSTRATE MATERIAL: BT.
7. DUMMY DIE: SIZE OPTIONAL.
8. DAISY CHAIN PATTERN (SEE PAGE 2).
9. MSL-3 RECOMMEND BAKING 24 HOURS @125°C TO REMOVE MOISTURE PRIOR TO SOLDERING TO PC BOARD.

PART NUMBER TABLE				
PART NUMBER	BALL ALLOY	Pb-FREE	RoHS	Si DIE
BGA192T.8C-DC165D	SAC305	YES	YES	YES
BGA192T.8-DC165D	SnPb	NO	NO	YES

APPROVALS	DATE				
DRAWN T. Au	7/22/2023				
ENG M. Hart	7/22/2023	TITLE		BGA192T.8-DC165D DAISY CHAIN BGA	
MFG		SCALE	SIZE	DRAWING NO.	REV
QA		6:1	A	581650	A
CUST		DO NOT SCALE DRAWING			SHEET 1 OF 3
REVISED					

BALL VIEW

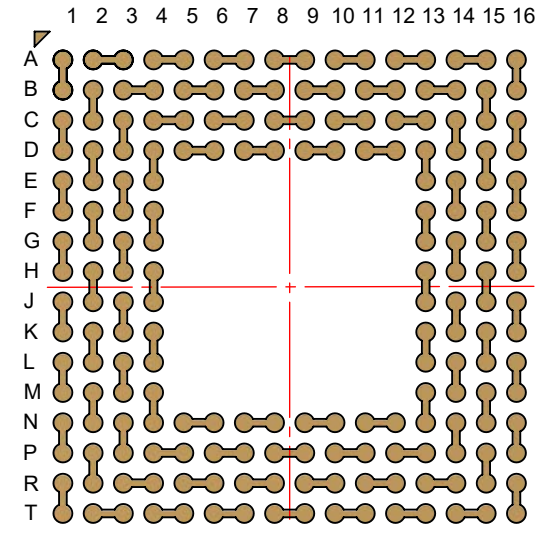
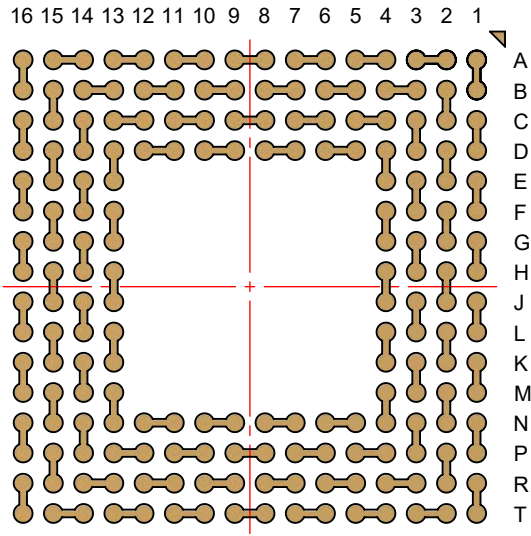

TEST VEHICLE BOARD TOP VIEW

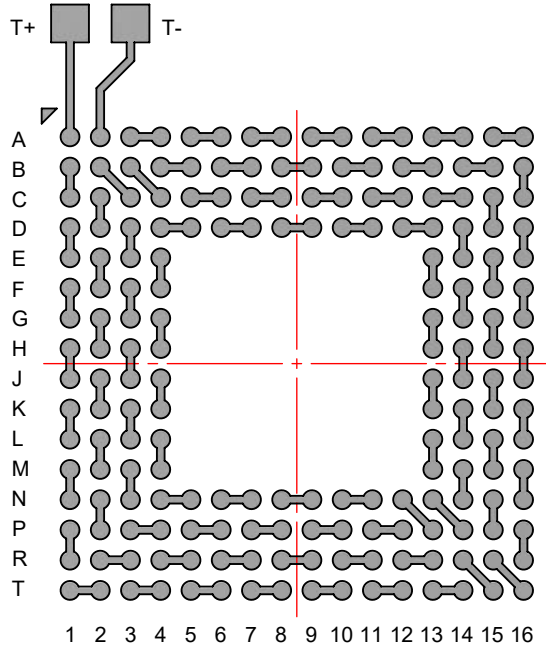

AFTER MOUNTING TO TEST BOARD (TOP X-RAY VIEW)

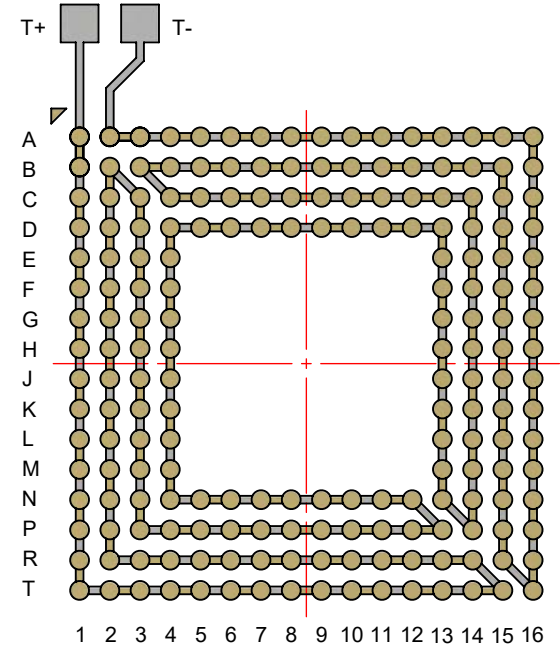

NOTES:

1. PCB BOARD DIMENSIONS ARE PRESENTED ONLY AS A GUIDELINE. DESIGNERS SHOULD USE THEIR OWN EXPERIENCE WHEN DESIGNING PCB.
2. PCB Cu BALL PAD DIAMETER: 0.50mm (19.7 mil).
3. PCB DAISY CHAIN TRACING LINE WIDTH: 0.203mm (8 mil).
4. SMD (SOLDER MASK DEFINED) PAD OPENING: \varnothing 0.40mm (15.7 mil).

TopLine[®]			
TITLE		BGA192T.8-DC165D DAISY CHAIN BGA	
SCALE	SIZE	DRAWING NO.	REV
5:1	A	581650	A
DO NOT SCALE DRAWING			SHEET 2 OF 3

MODEL WITH SOLDER BALLS

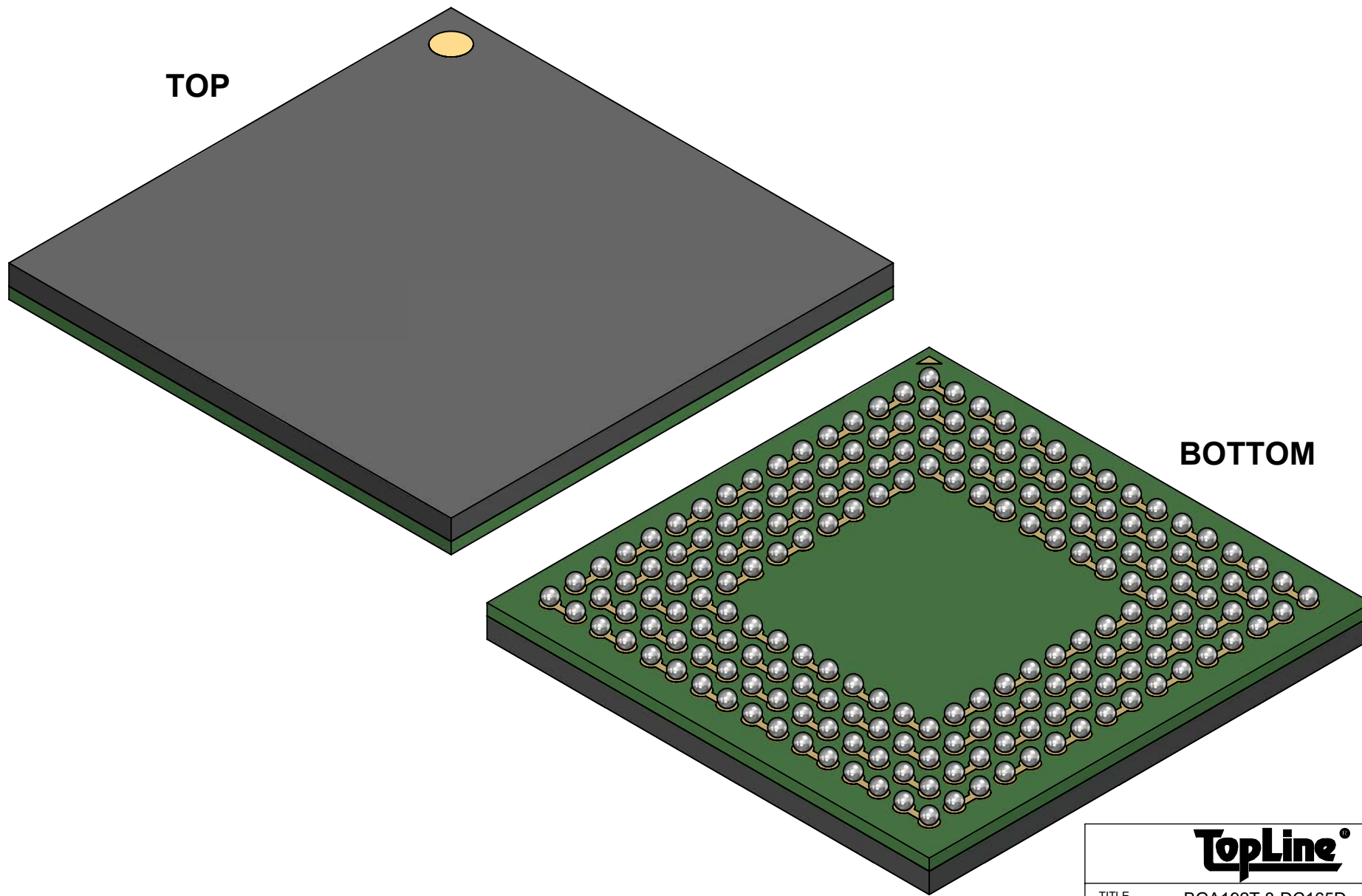

TOP

BOTTOM

TopLine[®]			
TITLE BGA192T.8-DC165D DAISY CHAIN BGA			
SCALE 8:1	SIZE A	DRAWING NO. 581650	REV A
DO NOT SCALE DRAWING			SHEET 3 OF 3